



## WBFBP-06C Plastic-Encapsulate Diode

### FMMBD4448HADW

SURFACE MOUNT SWITCHING DIODE ARRAYS

#### DESCRIPTION

Silicon epitaxial planar  
Switching Diode

#### FEATURES

- Ultra-Small Surface Mount Package
- Fast Switching Speed
- High Conductance

#### APPLICATION

For General Purpose Switching Applications, rectifiers  
For portable equipment:(i.e. Mobile phone,MP3, MD,CD-ROM,  
DVD-ROM, Note book PC, etc.)

#### WBFBP-06C

(2×2×0.5)  
unit: mm

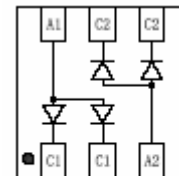
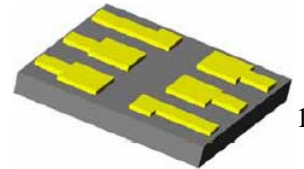

FMMBD4448HADW

Marking:KA6

#### Maximum Ratings and Electrical Characteristics, Single Diode @T<sub>A</sub>=25

Parameter	Symbol	Limits	Unit
Non-Repetitive Peak reverse voltage	V <sub>RM</sub>	100	V
Peak Repetitive peak reverse voltage	V <sub>RRM</sub>	80	V
Working Peak Reverse Voltage	V <sub>RWM</sub>		
DC Blocking Voltage	V <sub>R</sub>		
RMS Reverse Voltage	V <sub>R(RMS)</sub>	57	V
Forward Continuous Current	I <sub>FM</sub>	500	mA
Average Rectified Output Current	I <sub>O</sub>	250	mA
Non-Repetitive Peak forward surge current @=1.0μs @=1.0s	I <sub>FSM</sub>	4.0 2.0	A
Power Dissipation	P <sub>d</sub>	150	mW
Thermal Resistance Junction to Ambient	R <sub>θJA</sub>	625	°C/W
Junction temperature	T <sub>J</sub>	150	°C
Storage temperature range	T <sub>STG</sub>	-65 to +150	°C

#### Electrical Ratings @T<sub>A</sub>=25°C

Parameter	Symbol	Min.	Typ.	Max.	Unit	Conditions
Reverse Breakdown Voltage	V <sub>R</sub>	80			V	I <sub>R</sub> =100 μ A
Forward voltage	V <sub>F1</sub>	0.62		0.72	V	I <sub>F</sub> =5mA
	V <sub>F2</sub>			0.855	V	I <sub>F</sub> =10mA
	V <sub>F3</sub>			1.0	V	I <sub>F</sub> =100mA
	V <sub>F4</sub>			1.25	V	I <sub>F</sub> =150mA
Reverse current	I <sub>R1</sub>			0.1	μA	V <sub>R</sub> =70V
	I <sub>R2</sub>			25	nA	V <sub>R</sub> =20V
Capacitance between terminals	C <sub>T</sub>			3.5	pF	V <sub>R</sub> =6V,f=1MHz
Reverse Recovery Time	t <sub>rr</sub>			4	ns	V <sub>R</sub> =6V,I <sub>F</sub> =5mA

# Typical Characteristics

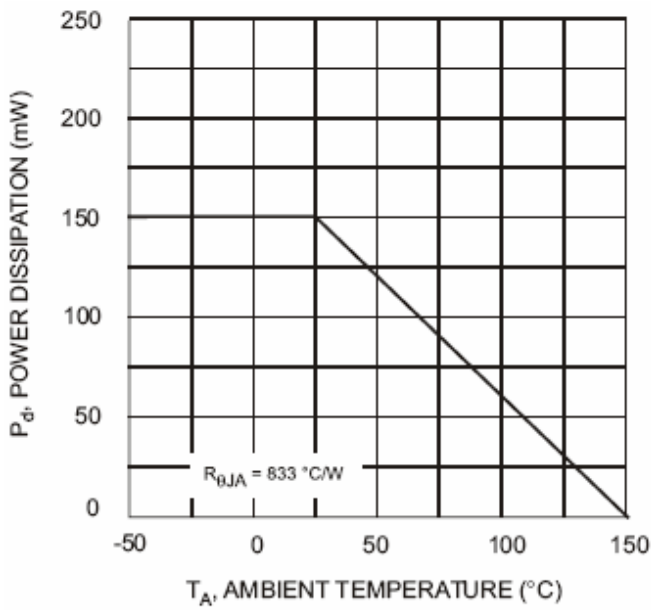

Fig. 1, Derating Curve - Total

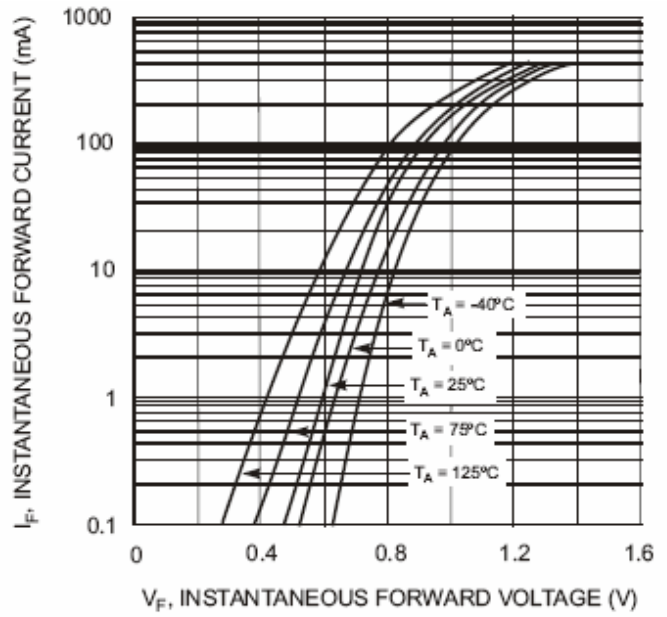

Fig. 2 Typical Forward Characteristics

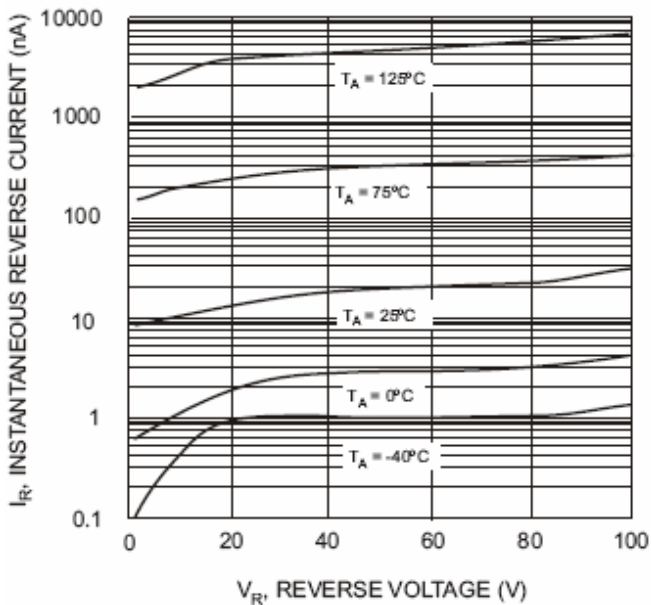

Fig. 3 Typical Reverse Characteristics

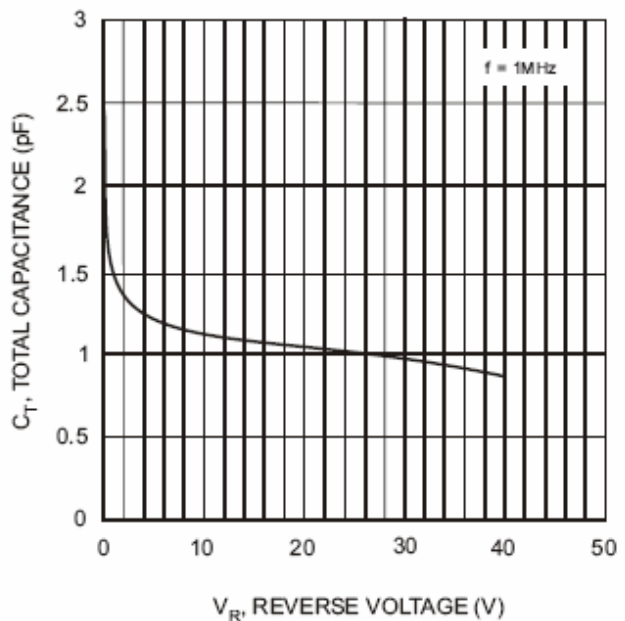
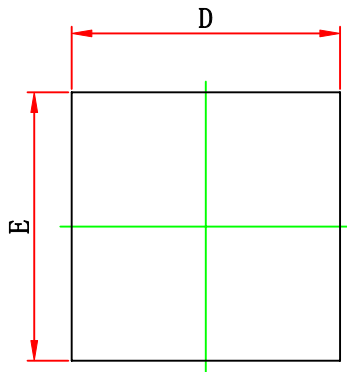

Fig. 4 Typical Capacitance vs. Reverse Voltage



### WBFBP-06C(2×2×0.5) PACKAGE OUTLINE DIMENSIONS



TOP VIEW

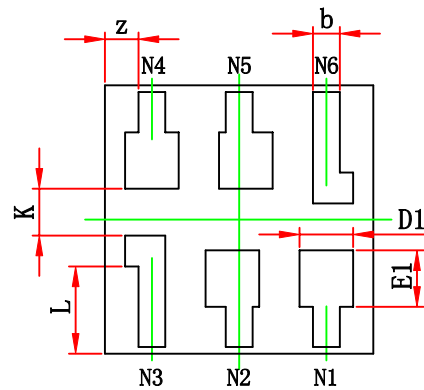

BOTTOM VIEW

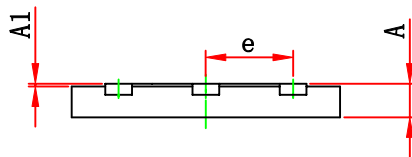

SIDE VIEW

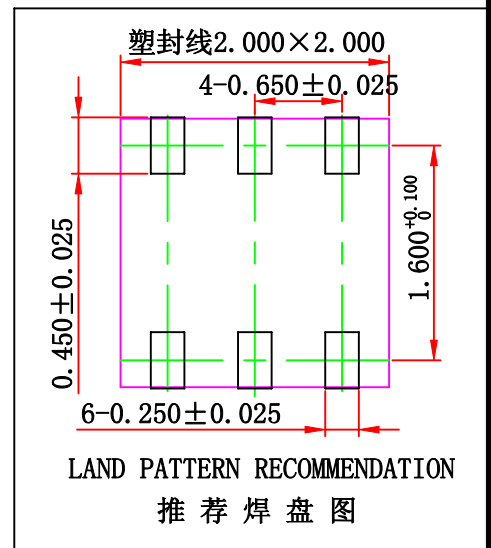

Symbol	Dimensions In Millimeters		Dimensions In Inches	
	Min.	Max.	Min.	Max.
A	0.450	0.550	0.018	0.022
A1	0.000	0.100	0.000	0.004
b	0.150	0.250	0.006	0.010
D	1.900	2.100	0.075	0.083
E	1.900	2.100	0.075	0.083
D1	0.420 REF.		0.017 REF.	
E1	0.420 REF.		0.017 REF.	
e	0.650 TYP.		0.026 TYP.	
L	0.650 REF.		0.026 REF.	
k	0.350 REF.		0.014 REF.	
z	0.500 REF.		0.020 REF.	

## APPLICATION CIRCUITS

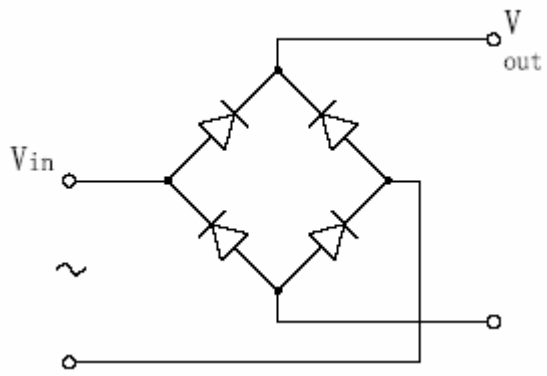

Bridge rectifiers